

6.16)

$$D: 0 \leq x \leq 1, 0 \leq y \leq 2, 0 \leq z \leq 4.$$

D har volym  $1 \cdot 2 \cdot 4 = 8$ .

$$\sqrt[3]{x} + y + \sqrt{z} \leq \sqrt[3]{1} + 2 + \sqrt{4} = 5$$

$$I \leq 8 \cdot 5 = 40.$$

$$\int_0^1 \left( \int_0^2 \left( \int_0^4 (\sqrt[3]{x} + y + \sqrt{z}) dz \right) dy \right) dx =$$

$$= 8 \int_0^1 \sqrt[3]{x} dx + 4 \int_0^2 y dy + 2 \int_0^4 \sqrt{z} dz =$$

$$= 8 \left[ \frac{3}{4} x^{4/3} \right]_0^1 + 4 \left[ \frac{y^2}{2} \right]_0^2 + 2 \left[ \frac{2}{3} z^{3/2} \right]_0^4 =$$

$$= 6 + 8 + \frac{32}{3} = \frac{74}{3}$$

6.17)

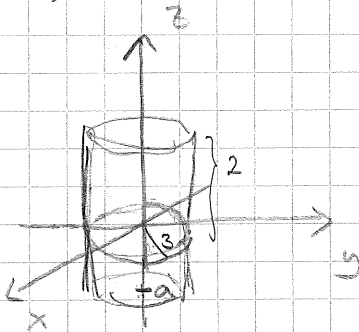

$$D = \{(x, y, z) : x^2 + y^2 \leq 9, a \leq z \leq 2+a\}$$

$$\iiint_D (x^2 + y^2) z \, dx \, dy \, dz = \iint_{x^2 + y^2 \leq 9} \left( \int_a^{2+a} (x^2 + y^2) z \, dz \right) dx \, dy$$

$$= \int_0^{2\pi} \int_0^3 \rho^2 \rho \, d\rho \, d\phi \cdot \int_a^{2+a} z \, dz = 2\pi \left[ \frac{\rho^4}{4} \right]_0^3 \cdot \left[ \frac{z^2}{2} \right]_a^{2+a} =$$

$$= \frac{81\pi}{4} ((2+a)^2 - a^2) = 81\pi(1+a).$$

6.18)

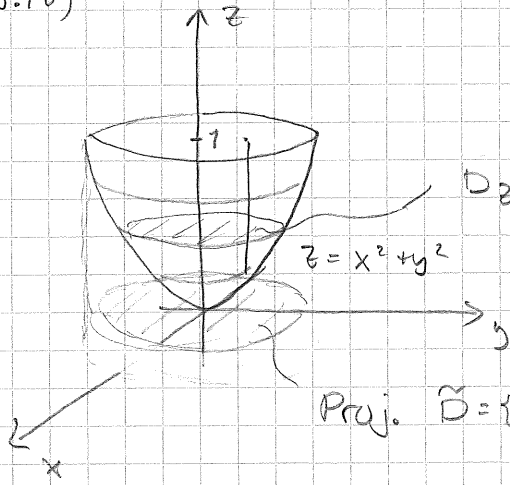

$$D_z = \{(x, y) : x^2 + y^2 \leq z\}, \quad a=0, b=1.$$

$$\text{Proj. } \tilde{D} = \{(x, y) : x^2 + y^2 \leq 1\}$$

$$A(x, y) = x^2 + y^2, \quad B(x, y) = 1$$

$$\iiint_D z \sqrt{x^2 + y^2} \, dx \, dy \, dz = \iint_{\tilde{D}} \left( \int_{x^2+y^2}^1 z \sqrt{x^2 + y^2} \, dz \right) dx \, dy =$$

$$= \iint_{\tilde{D}} \sqrt{x^2 + y^2} \left( \frac{1}{2} - \frac{(x^2 + y^2)^2}{2} \right) dx \, dy =$$

$$= \frac{1}{2} \int_0^{2\pi} \left( \int_0^1 \rho (1 - \rho^4) \rho \, d\rho \right) d\varphi =$$

$$= \pi \int_0^1 (\rho^2 - \rho^6) \, d\rho = \pi \left[ \frac{\rho^3}{3} - \frac{\rho^7}{7} \right]_0^1 = \pi \left( \frac{1}{3} - \frac{1}{7} \right) = \underline{\underline{\frac{4\pi}{21}}}$$

6.19)

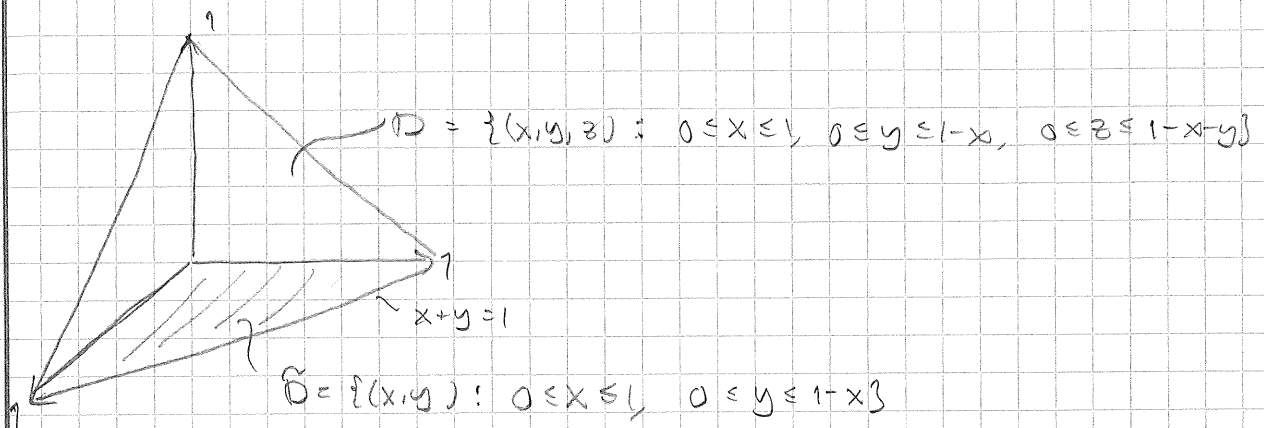

$$D = \{(x,y,z) : 0 \leq x \leq 1, 0 \leq y \leq 1-x, 0 \leq z \leq 1-x-y\}$$

$$\iiint_D \frac{dx dy dz}{(1+x+y+z)^3} = \int_0^1 \left( \int_0^{1-x} \left( \int_0^{1-x-y} \frac{1}{(1+x+y+z)^3} dz \right) dy \right) dx =$$

$$= \int_0^1 \left( \int_0^{1-x} \left[ \frac{-1}{2(1+x+y+z)^2} \right]_{z=0}^{1-x-y} dy \right) dx =$$

$$= \int_0^1 \left( \int_0^{1-x} \left( \frac{-1}{2 \cdot 2^2} + \frac{1}{2(1+x+y)^2} \right) dy \right) dx =$$

$$= \int_0^1 \left[ \frac{-y}{8} - \frac{1}{2(1+x+y)} \right]_{y=0}^{1-x} dx =$$

$$= \int_0^1 \left( \frac{-(1-x)}{8} - \frac{1}{2 \cdot 2} + \frac{1}{2(1+x)} \right) dx =$$

$$= \left[ \frac{x^2}{16} - \frac{3x}{8} + \frac{1}{2} \ln(1+x) \right]_0^1 = \frac{1}{16} - \frac{3}{8} + \frac{1}{2} \ln 2 =$$

$$= \underline{\underline{\ln 2 - \frac{5}{16}}}$$

6.20)

$$D = \{(x, y, z) : 0 \leq z \leq y \leq x^2 \leq 1\}$$

$$\begin{aligned} a) D &= \{(x, y, z) : -1 \leq x^2 \leq 1, 0 \leq y \leq x^2, 0 \leq z \leq y\} \\ &= \{(x, y, z) : -1 \leq x \leq 1, 0 \leq y \leq x^2, 0 \leq z \leq y\}. \end{aligned}$$

$$D_x = \{(y, z) : 0 \leq y \leq x^2, 0 \leq z \leq y\}, \quad -1 \leq x \leq 1.$$

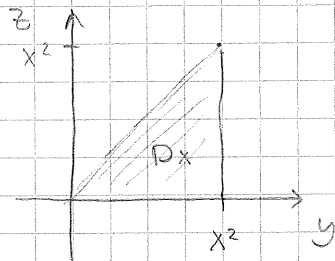

b)

$$0 \leq y \leq 1,$$

$$D_y = \{(x, z) : 0 \leq z \leq y, y \leq x^2 \leq 1\} =$$

$$= \{(x, z) : 0 \leq z \leq y, \sqrt{y} \leq x \leq 1\}$$

$$\cup \{(x, z) : 0 \leq z \leq y, \sqrt{y} \leq -x \leq 1\}$$

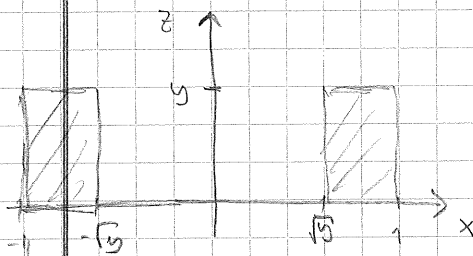

c)

$$0 \leq z \leq 1$$

$$D_z = \{(x, y) : z \leq y \leq x^2, z \leq x^2 \leq 1\}$$

$$= \{(x, y) : z \leq y \leq x^2, \sqrt{z} \leq x \leq 1\} \cup \{(x, y) : z \leq y \leq x^2, \sqrt{z} \leq -x \leq 1\}$$

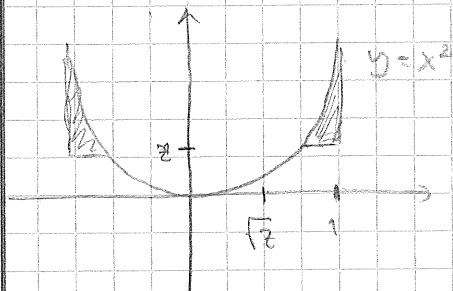

6.20)

d)  $\tilde{D} = \{(x, y) : 0 \leq y \leq x^2, 0 \leq x^2 \leq 1\} =$   
 $= \{(x, y) : 0 \leq y \leq x^2, -1 \leq x \leq 1\}$

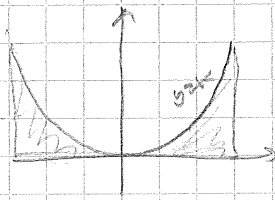

$D_{xy} = \{z : 0 \leq z \leq y\}$

e)  $\tilde{D} = \{(x, z) : 0 \leq z \leq x^2 \leq 1\}$

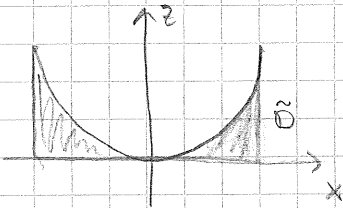

$D_{xz} = \{y : z \leq y \leq x^2\}$

f)  $\tilde{D}_1 = \{(y, z) : 0 \leq z \leq y \leq 1\}, D_{yz} = \{x : -1 \leq x \leq -\sqrt{y}\} \cup$

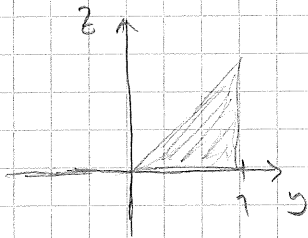

$\cup \{x : \sqrt{y} \leq x \leq 1\}$

$$6.21) \iiint_D \frac{z}{1+x^2} dx dy dz =$$

$$D = \{(x, y, z) : 0 \leq z \leq y \leq x^2 \leq 1\}$$

$$\tilde{D} = \{(x, y) : 0 \leq y \leq x^2, -1 \leq x \leq 1\}, \quad 0 \leq z \leq y$$

$$= \iint_{\tilde{D}} \left( \int_0^y \frac{z}{1+x^2} dz \right) dx dy = \iint_{\tilde{D}} \frac{y^2}{2(1+x^2)} dx dy =$$

$$= \int_{-1}^1 \left( \int_0^{x^2} \frac{y^2}{2(1+x^2)} dy \right) dx = \int_{-1}^1 \frac{x^6}{6(1+x^2)} dx$$

$$= \frac{x^6}{6(1+x^2)} - \frac{x^6(1+x^2) - x^4}{6(1+x^2)} = \frac{x^4}{6} - \frac{x^2(1+x^2) - x^2}{6(1+x^2)}$$

$$= \frac{x^4 - x^2}{6} - \frac{x^2}{6(1+x^2)} = \frac{x^4 - x^2 + 1}{6} - \frac{1}{6(1+x^2)}$$

$$= \left[ \frac{x^5}{30} - \frac{x^3}{18} + \frac{x}{6} - \frac{1}{6} \arctan x \right]_{-1}^1 =$$

$$2 \left( \frac{1}{30} - \frac{1}{18} + \frac{1}{6} - \frac{\pi}{24} \right) = \frac{1}{15} - \frac{1}{9} + \frac{1}{3} - \frac{\pi}{12} = \frac{3 - 5 + 15}{45} - \frac{\pi}{12} =$$

$$= \frac{13}{45} - \frac{\pi}{12}$$

6.24)  $D$  begränsas av  $x \geq 0, y \geq 0, z \geq 0, z = y$  och  $z = 4 - x^2$

Projektion  $\tilde{D}$  på  $xz$ -planet ges av

$0 \leq x \leq 2, 0 \leq z \leq 4 - x^2$ , och för varje

$(x, z) \in \tilde{D}$  får vi gränserna  $0 \leq y \leq z$ .

$$\begin{aligned} \iiint_D 2x \, dx \, dy \, dz &= \iint_{\tilde{D}} \left( \int_0^z 2x \, dy \right) dx \, dz = \\ &= \int_0^2 \left( \int_0^{4-x^2} 2xz \, dz \right) dx = \int_0^2 \left[ xz^2 \right]_{z=0}^{4-x^2} dx = \int_0^2 x(4-x^2)^2 dx = \\ &= \left[ \frac{-(4-x^2)^3}{3 \cdot 2} \right]_0^2 = \frac{32}{3} \end{aligned}$$

6.25)

$$I = \iiint_D 3z \, dx \, dy \, dz, \quad D \text{ har volymen } \frac{2\pi}{3}.$$

Eftersom  $0 \leq 3z \leq 3$  på  $D$  gäller att

$$0 \leq I \leq 3 \cdot \frac{2\pi}{3} = 2\pi.$$

$D$  ges i polära koordinater av  $0 \leq r \leq 1, 0 \leq \varphi \leq 2\pi, 0 \leq \theta \leq \pi/2$

$$\begin{aligned} I &= \int_0^{\pi/2} \left( \int_0^{2\pi} \left( \int_0^1 3r \cos \theta r^2 \sin \theta \, dr \right) d\varphi \right) d\theta = \\ &= 2\pi \int_0^{\pi/2} \cos \theta \sin \theta \, d\theta \cdot \int_0^1 3r^3 \, dr = 2\pi \int_0^{\pi/2} \frac{\sin 2\theta}{2} \, d\theta \cdot \left[ \frac{3r^4}{4} \right]_0^1 = \\ &= \frac{3\pi}{2} \left[ -\frac{\cos 2\theta}{4} \right]_0^{\pi/2} = \frac{3\pi}{4} \end{aligned}$$



6.26)

a)

$$\iiint_{B(0,1)} (z^2 - x^2 - y^2) dx dy dz = \int_0^{\pi} \int_0^{2\pi} \int_0^1 (r^2 \cos^2 \theta - r^2 \sin^2 \theta) r^2 \sin \theta dr d\varphi d\theta$$

$$= 2\pi \int_0^{\pi} (2 \cos^2 \theta - r^2) \sin \theta d\theta \cdot \int_0^1 r^4 dr =$$

$$= 2\pi \left[ -\cos \theta - \frac{2 \cos^3 \theta}{3} \right]_0^{\pi} \cdot \left[ \frac{r^5}{5} \right]_0^1 = \underline{\underline{\frac{4\pi}{15}}}$$

b) Gränser i sfäriska koordinater  $0 \leq r \leq 1$ ,  $-\pi/2 \leq \varphi \leq \pi/2$ ,  $0 \leq \theta \leq \pi$

$$\int_0^{\pi} \int_{-\pi/2}^{\pi/2} \int_0^1 (r \cos \varphi \sin \theta e^{r^2} \cdot r^2 \sin \theta dr) d\varphi d\theta =$$

$$= \int_0^{\pi} \sin^2 \theta d\theta \cdot \int_{-\pi/2}^{\pi/2} \cos \varphi d\varphi \cdot \int_0^1 r^3 e^{r^2} dr =$$

$$= \int_0^{\pi} \frac{1 - \cos 2\theta}{2} d\theta \cdot \left[ \sin \varphi \right]_{-\pi/2}^{\pi/2} \left( \left[ \frac{r^2}{2} e^{r^2} \right]_0^1 - \int_0^1 r e^{r^2} dr \right) =$$

$$= \frac{\pi}{2} \cdot 2 \cdot \left[ \frac{r^2}{2} e^{r^2} - \frac{e^{r^2}}{2} \right]_0^1 = \pi \left( \frac{e}{2} - \frac{e}{2} - 0 + \frac{1}{2} \right) = \underline{\underline{\frac{\pi}{2}}}$$

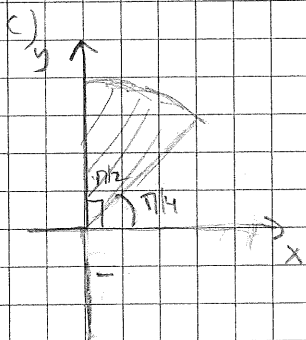

$0 \leq r \leq \sqrt{3}$ ,  $-\pi/4 \leq \varphi \leq \pi/4$ ,  $0 \leq \theta \leq \pi$ .

$$\int_0^{\pi} \int_{-\pi/4}^{\pi/4} \int_0^{\sqrt{3}} (r \cos \varphi \sin \theta r^2 \sin \theta dr) d\varphi d\theta =$$

$$= \int_0^{\pi} \sin^2 \theta d\theta \int_{-\pi/4}^{\pi/4} \cos \varphi d\varphi \int_0^{\sqrt{3}} r^3 dr = \frac{\pi}{2} \cdot \left[ \sin \varphi \right]_{-\pi/4}^{\pi/4} \cdot \left[ \frac{r^4}{4} \right]_0^{\sqrt{3}} =$$

$$= \frac{\pi}{2} \cdot \left( 1 - \frac{1}{\sqrt{2}} \right) \cdot \frac{9}{4} = \underline{\underline{\frac{9\pi(2-\sqrt{2})}{16}}}$$



6.27)

$$a) \begin{cases} u = x + y + z \\ v = x + 2y + 3z \\ w = x + 4y + 9z \end{cases} \Leftrightarrow \dots \Leftrightarrow \begin{cases} x = 3u - \frac{5v}{2} + \frac{w}{2} \\ y = -3u + 4v - w \\ z = \frac{2u - 3v + w}{2} \end{cases}$$

$$\frac{d(u,v,w)}{d(x,y,z)} = \begin{vmatrix} 1 & 1 & 1 \\ 1 & 2 & 3 \\ 1 & 4 & 9 \end{vmatrix} = \begin{vmatrix} 1 & 1 & 1 \\ 0 & 1 & 2 \\ 0 & 3 & 8 \end{vmatrix} = \begin{vmatrix} 1 & 1 & 1 \\ 0 & 1 & 2 \\ 0 & 0 & 2 \end{vmatrix} = 2$$

$$\text{Så } dx dy dz = \frac{1}{2} du dv dw$$

$$0 \leq u \leq 1, \quad 0 \leq v \leq 1, \quad 0 \leq w \leq 1$$

$$y - x - z = \dots = -7u + 8v - 2w$$

$$\iiint_0^1 (y-x-z) dx dy dz = \int_0^1 \int_0^1 \int_0^1 (-7u + 8v - 2w) \frac{1}{2} du dv dw$$

$$= \text{1 Av symmetrisk!} = -\frac{1}{2} \int_0^1 u du = \underline{\underline{-\frac{1}{4}}}$$

b)

Med basbytet till basen

$$((1,1,0), (1,0,1), (0,1,1)) \text{ för } u$$

$$\begin{pmatrix} x \\ y \\ z \end{pmatrix} = \begin{pmatrix} 1 & 1 & 0 \\ 1 & 0 & 1 \\ 0 & 1 & 1 \end{pmatrix} \begin{pmatrix} u \\ v \\ w \end{pmatrix} \Leftrightarrow \begin{cases} x = u+v \\ y = u+w \\ z = v+w \end{cases} \quad \frac{d(x,y,z)}{d(u,v,w)} = \begin{vmatrix} 1 & 1 & 0 \\ 1 & 0 & 1 \\ 0 & 1 & 1 \end{vmatrix} = -2$$

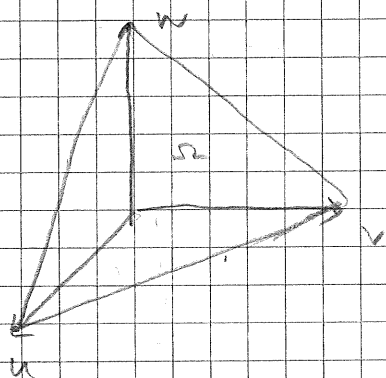
Punkterna  $(0,0,0), (1,1,0), (1,0,1)$  och  $(0,1,1)$ är i UVW koordinaterna  $(0,0,0), (1,0,0), (0,1,0), (0,0,1)$ .

$$\Omega: 0 \leq u \leq 1, \quad 0 \leq v \leq 1-u, \quad 0 \leq w \leq 1-u-v$$

$$\iiint_{\Omega} x dx dy dz = \iiint_{\Omega} (u+v) 2 du dv dw$$

$$= \text{Symm!} = 2 \iiint_{\Omega} u du dv dw =$$

$$= 4 \int_0^1 \left( \int_0^{1-u} \left( \int_0^{1-u-v} u dw \right) dv \right) du = 4 \int_0^1 \left( \int_0^{1-u} u(1-u-v) dv \right) du = \dots = \frac{1}{6}$$

6.22)

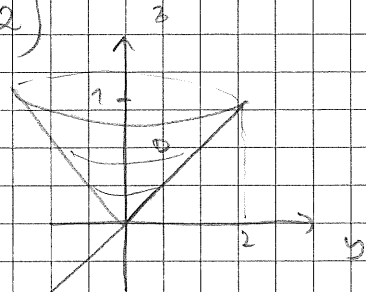

$$D: 0 \leq z \leq 1, \sqrt{x^2 + y^2} \leq 2z$$

$$\int_0^1 \left( \int_0^{2\pi} \left( \int_0^{2z} (\rho^2 \sin^2 \phi + z^2) \rho d\rho \right) d\phi \right) dz =$$

$$= \int_0^1 \left( \int_0^{2\pi} \left[ \frac{\rho^4}{4} \sin^2 \phi + \frac{\rho^2}{2} z^2 \right]_{\rho=0}^{2z} d\phi \right) dz = \int_0^1 \left( \int_0^{2\pi} (4z^4 \sin^2 \phi + 2z^4) d\phi \right) dz$$

$$= \int_0^1 2z^4 dz \cdot \int_0^{2\pi} (1 + 2\sin^2 \phi) d\phi = \left[ \frac{2z^5}{5} \right]_0^1 \cdot \left[ \phi + \phi - \frac{\sin 2\phi}{2} \right]_0^{2\pi}$$

$$= \underline{\underline{\frac{8\pi}{5}}}$$

$$6.23) \quad x-y \leq z \leq x+y, \quad |x|+|y| \leq 1.$$

$$x-y \leq x+y \Leftrightarrow y \geq 0$$

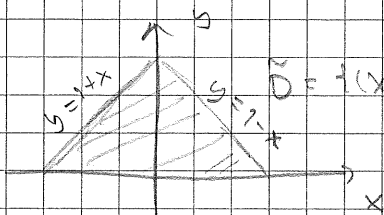

$$\tilde{D} = \{(x,y) : y \geq 0, |x|+|y| \leq 1\} =$$

$$= \{(x,y) : 0 \leq y \leq 1, y-1 \leq x \leq 1-y\}$$

$$\iiint_D y e^z dx dy dz = \iint_{\tilde{D}} \left( \int_{x-y}^{x+y} y e^z dz \right) dx dy =$$

$$= \iint_{\tilde{D}} y (e^{x+y} - e^{x-y}) dx dy = \int_0^1 \left( \int_{y-1}^{1-y} y (e^{x+y} - e^{x-y}) dx \right) dy =$$

$$= \int_0^1 y (e^y - e^{-y}) \cdot (e^{1-y} - e^{y-1}) dy = \dots = \underline{\underline{\frac{1}{e}}}$$

$$= \int_0^1 y (e^y - e^{-y}) (e^{1-y} - e^{y-1}) dy =$$

$$= \int_0^1 y (e^y - e^{-y}) (e^{1-y} - e^{y-1}) dy =$$

"